

## Details of installation

### Wires collection

Take apart the ornament cap of the main bar (2-5) after connecting the GPCM Main Bar to the fixation (1-1), then put the power cords into the storage gap. At last, re-install the ornament cap back to the main bar (2-5) as figure 6、7 and 8.

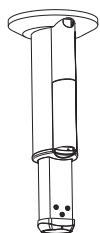

figure 6

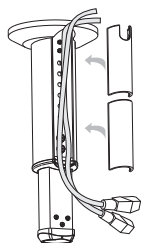

figure 7

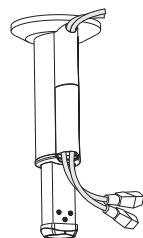

figure 8

### Height Adjustment

Take apart the ornament cap of the main bar (2-3) and loosen the front positioning screws. Adjust the subsidiary bar (2-3) to the required position, and then install the ornament cap back to the main bar (2-3) as figure 9.

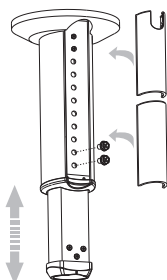

figure 9

### Installation Base

A hexagon screw is located at the back of the adjuster. Loosen it to adjust the suitable angle of the projector.

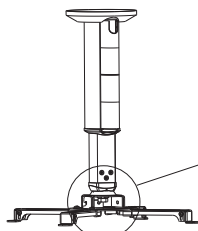

figure 10

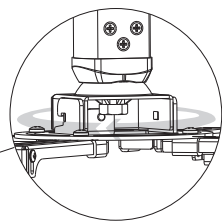

figure 11

### Installation of main bar

1. Firstly, please confirm how many installation holes the projector has 3 or 4.
2. If there are 3 holes, the installation arms (4-2) need to be taken apart from Installation bracket firstly. Connect 3 installation arms (4-2) to the projector, and then connect the installation arms (4-2) to the installation base (4-5). However, the installation base needs to be the center of projector. Figure 12.
3. Connect the installation arms to the projector conversely if the distance of installation holes is less than 120mm. Connect the installation arms (4-2) to the installation base (4-5) via sliding installation button (4-4) as figure 13.
4. Rotate the adjustable nuts (4-3) for adjusting the height of installation arms (4-2) if the installation holes are not at the same level as figure 14.
5. The front or back of adjuster must be parallel to the surface of projector as figure 15.

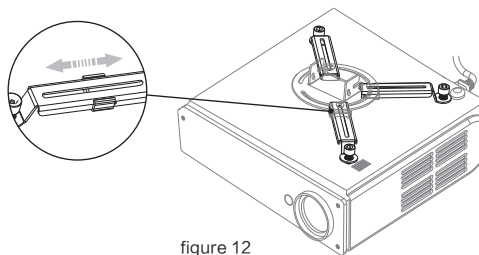

figure 12

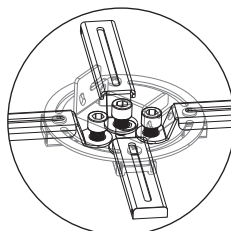

figure 13

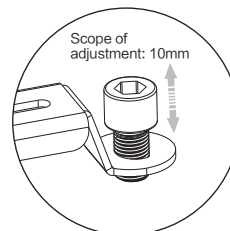

figure 14

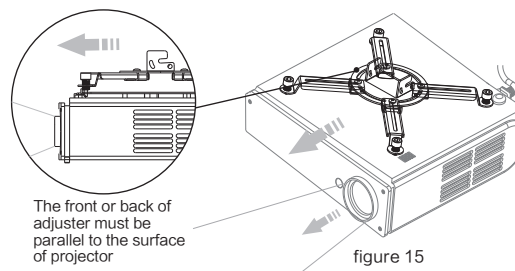

figure 15

### Grandview Crystal Screen Canada Ltd.

#11- 3751 North Fraser Way,  
Marine Way Business Centre,  
Burnaby, BC, Canada V5J 5G4  
Tel: 1-604-412-9777 Fax: 1-604-412-9796  
Website: www.grandviewscreen.ca

### Guangzhou Grandview Crystal Screen Co., Ltd.

No.43,Guomao Road South, Hualong Town,  
Panyu District, Guangzhou City, China  
Tel: +8620-8489-9499 Fax: +8620-8480-3343  
Website: www.grandviewscreen.com  
www.grandviewscreen.com.cn

# Grandview

## Instruction Manual

### Projector Lift



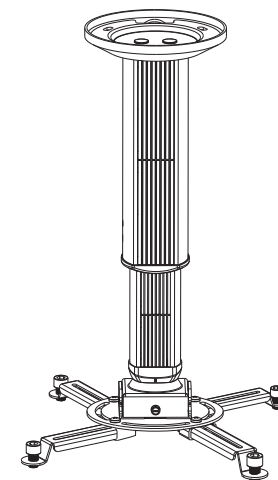

Applicable Model  
GPCM-F

### Please read before use

Thank you for purchasing our product! Please read the manual carefully to ensure this projector lift is suitable to your projector equipment.



### Cautious

-  **Warning** For safety reason, the minimum load of the ceiling must be at least 20kg.
-  **Maximum load** Maximum load of the projector lift is 20kg.
-  **Important** Do not over incline the projector.
-  **Do not disassemble** Do not disassemble any part of the projector lift.

## Parts

GPCM-F is combined by GPCM and GPF

### GPCM Main Bar Overview

- 1-1 Fixation
- 1-2 Top Cap
- 2-1 Main Bar
- 2-2 Subsidiary Bar
- 2-3 Ornament Board of Main Bar
- 2-4 Ornament Board of Subsidiary Bar
- 2-5 Ornament Cap of Main Bar

### GPF Adjuster Overview

- 3-1 Adjuster
- 3-2 Hook
- 4-1 Installation Bracket
- 4-2 Installation Arm
- 4-3 Adjustable Nut
- 4-4 Sliding Installation Button
- 4-5 Installation Base
- 4-6 Vertical Adjusting Button

### Accessories:

- 1. M6x25 Tapping Screw (3sets)
- 2. M5x10 Philips Screw/  
Washer/Spring Washer (4sets)
- 3. M4x8 Socket Cap Screw (6pcs)
- 4. M5x8 Philips Screw (2pcs)
- 5. M3x30 Philips Screw (4pcs)
- 6. M4x30 Philips Screw (4pcs)
- 7. M5x30 Philips Screw (4pcs)

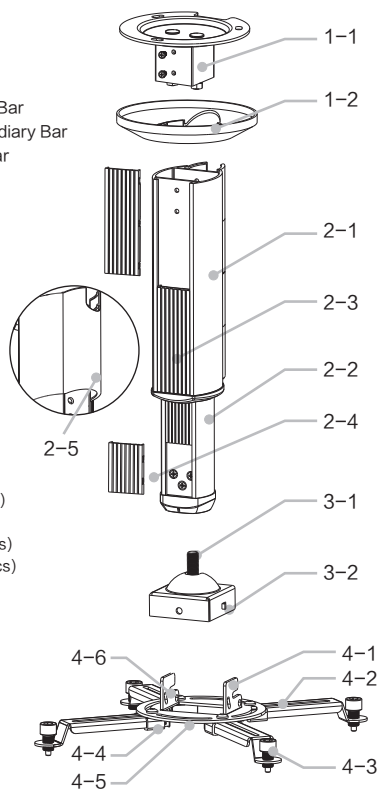

## Scope of Installation(Projector lift)

Scope for installation (H is the distance between ceiling and projector)

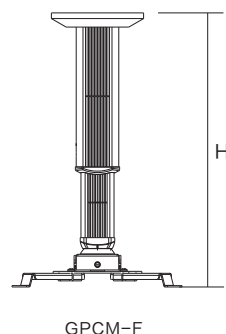

## 3 Steps Installation

- 1 Install the fixation on the ceiling using screws (Accessory no. 1) as figure 1. GPCM-F can be installed to the concrete roof with ceiling or without ceiling, as figure 2 and figure 3.

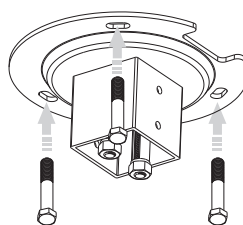

figure 1

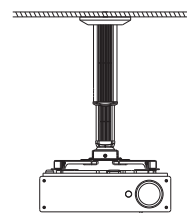

figure 2

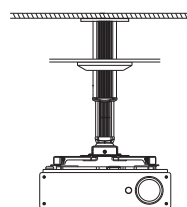

figure 3

- 2 Connect the adjuster to GPCM Main Bar, and then fasten with the screws (Accessory no. 2). Put the cables into place and fasten the screws on the on the main bar(2-1). Install the Ornament Board as figure 4.

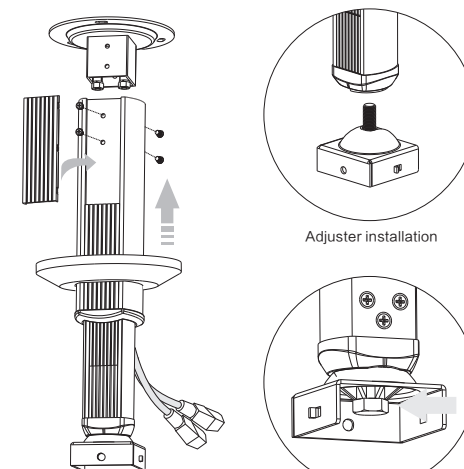

figure 4

- 3 Connect the base(already installed with the projector) by hooking on the adjuster as figure 5. Lastly, tighten the screw.

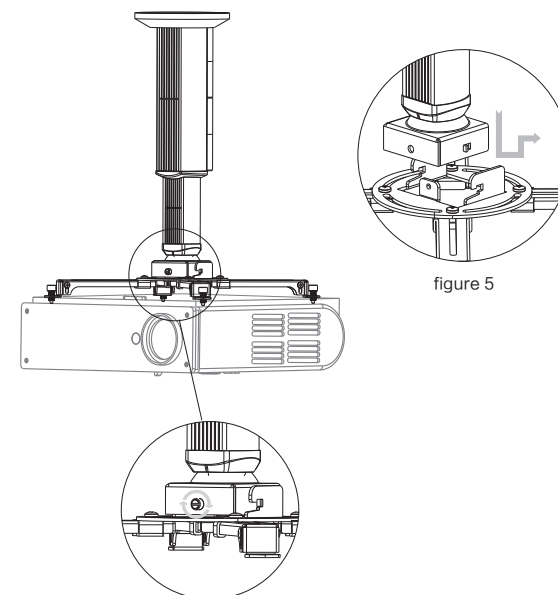

figure 5

## Scope of Installation(Projector)

Scope for installation (Installation hole of projector):

Maximum scope for installation: 365mm diameter

Minimum scope for installation: 50mm diameter

Note: Connect the installation arms to the projector conversely for different installation holes of projector.

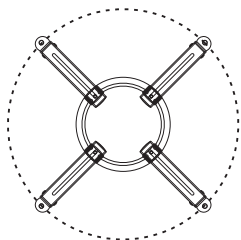

Maximum diameter: 365mm

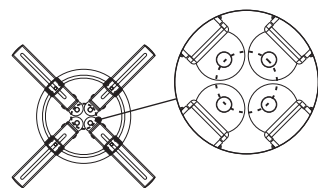

Minimum diameter: 50mm