

Details of installation

Wires collection

If the volume of power wires are less than diameter of main bar (2-1) that please put this power wires inside the main bar directly. But if the volume is greater than the diameter, please take apart back ornament board (2-4 and 2-5) and positioning button (2-6) from main bar (2-1) as figure 8. And then stay the power cord into the main bar (2-1), figure 9 Finally, re-install the back ornament board (2-4) from the other end, and then install positioning button (2-6) and back ornament board (2-5), figure 10.

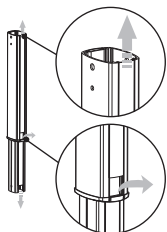

figure 8

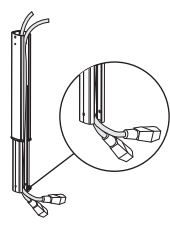

figure 9

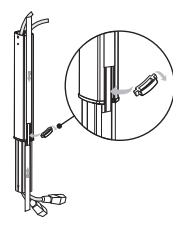

figure 10

Height adjustment

Adjust the main bar (2-1) to required height after taking apart the front ornament board (2-3) and loosening the front positioning screw. And then, re-install the front positioning screw and the front ornament board (2-3), figure 11. (The height of GPCN-D200 can not be adjusted; the main bar of GPCN-D3040 is separated by 4 segments, each segment is 25mm; the main bar of GPCN-D4060 is separated by 8 segments, each segment is 25mm)

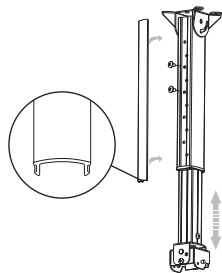

figure 11

Angle adjustment

1. Loosen the positioning screws (front and back) for adjusting the angle, and then rotate the screwdriver for fine turning to the required angle as figure 12.
2. Loosen the positioning screws (left and right) for adjusting the angle, and then rotate the screwdriver for fine turning to the required angle as figure 13.

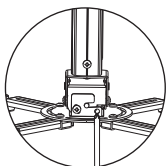
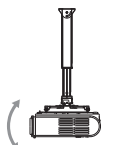

figure 12



The angle of vertical tilt: $\pm 15^\circ$

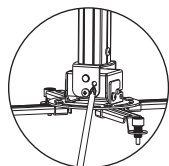
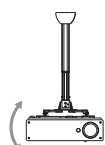

figure 13



The angle of horizontal tilt: $\pm 5^\circ$

Installation of main bar

1. Firstly, please confirm how many installation holes the projector has? 3 or 4
2. If there are 3 holes, the installation arms (4-2) need to be taken apart from installation bracket firstly. Connect 3 installation arms (4-2) to the projector, and then connect the installation arms (4-2) to the installation base (4-5) However, the installation base needs to be the center of projector. Figure 14.
3. Connect the installation arms to the projector conversely if the distance of installation holes is less than 120mm. Connect the installation arms (4-2) to the installation base (4-5) via sliding installation button (4-4) as figure 15
4. Rotate the adjustable nuts (4-3) for adjusting the height of installation arms (4-2) if the installation holes are not at the same level as figure 16.
5. The front or back of adjuster must be parallel to the surface of projector as figure 17.

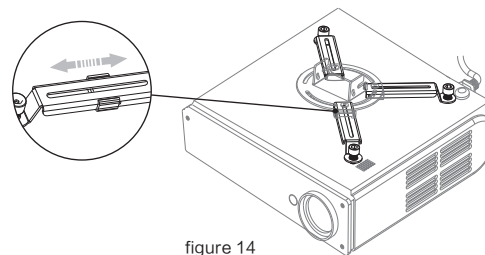

figure 14

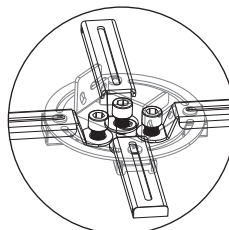

figure 15

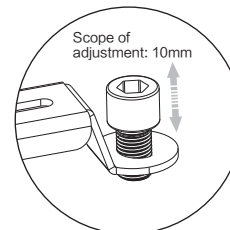

figure 16

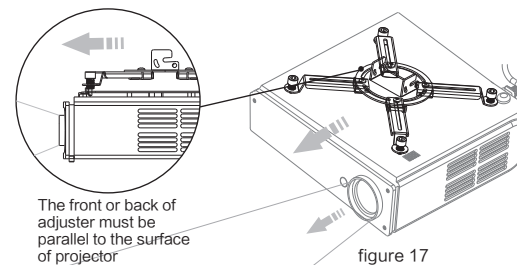

figure 17

Grandview Crystal Screen Canada Ltd.

#11- 3751 North Fraser Way,
Marine Way Business Centre,
Burnaby, BC, Canada V5J 5G4
Tel: 1-604-412-9777 Fax: 1-604-412-9796
Website: www.grandviewscreen.ca

Guangzhou Grandview Crystal Screen Co., Ltd.

No.43,Guomao Road South, Hualong Town,
Panyu District, Guangzhou City, China
Tel: +8620-8489-9499 Fax: +8620-8480-3343
Website: www.grandviewscreen.com
www.grandviewscreen.com.cn

Grandview®

Instruction Manual

Projector Ceiling Mount

Applicable Model
GPCN-D200
GPCN-D3040
GPCN-D4060

Please read before using

Thank you for purchasing our products. Please read the instruction manual carefully in order to ensure this projector lift is suitable for your projection equipment.

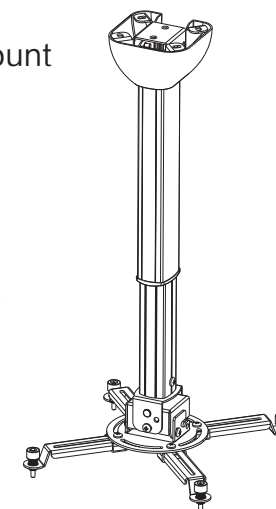

Cautious

Warnings For safety, the minimum weight of ceiling must be 10KG

Weight The maximum weight of installation bracket is 10Kg

Caution Please do not incline the projector the extremely.

Do not take apart Please do not take apart the accessories of projector ceiling mount.

Parts

GPCN-D is combined by GPCN and GPD

GPCN Main Bar Overview

- 1-1 Top Cap
- 1-2 Fixation
- 1-3 Sliding Adjusting Hole
- 2-1 Main Bar
- 2-2 Subsidiary Bar
- 2-3 Front Ornament Board
- 2-4 Back Ornament Board of Main Bar
- 2-5 Back Ornament Board of Subsidiary Bar
- 2-6 Moving Button

GPD Adjustment Overview

- 3-1 Adjuster
- 3-2 Hanging Button
- 3-3 Horizontal Adjusting Hole
- 4-1 Installation Bracket
- 4-2 Vertical Adjusting Hole
- 4-3 Installation Arm
- 4-4 Adjustable Nut
- 4-5 Sliding Installation Button
- 4-6 Installation Base

Accessories:

- ① M6x25 Tapping Screw (4sets)
- ② Ø6x50 Wood Screw (4pcs)
- ③ M5x8 Philips Screw (2pcs)
- ④ M5x16 Philips Screw (6pcs)
- ⑤ M5x30 Philips Screw (4pcs)
- ⑥ M4x30 Philips Screw (4pcs)
- ⑦ M3x30 Philips Screw (4pcs)

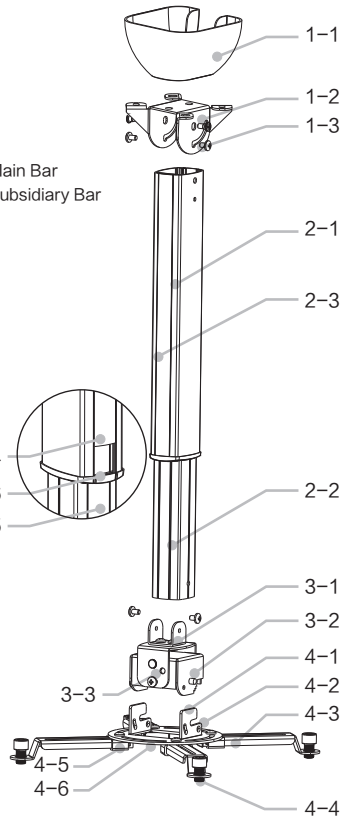

Scope

Scope for installation (Installation hole of projector):

Maximum scope for installation: 310mm diameter

Minimum scope for installation: 40mm diameter

Note: Connect the installation arms to the projector conversely for different installation holes of projector.

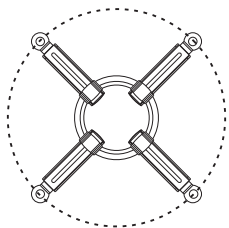

Maximum diameter: 310mm

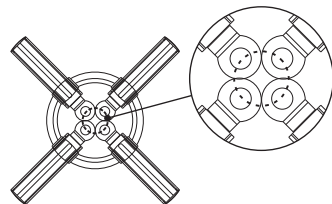

Minimum diameter: 40mm

Scope

Scope for installation (H is the distance between ceiling and projector)

The H of GPCN-D200 is 200mm

The H of GPCN-D30/40 is 300mm-400mm

The H of GPCN-D40/60 is 400mm-600mm

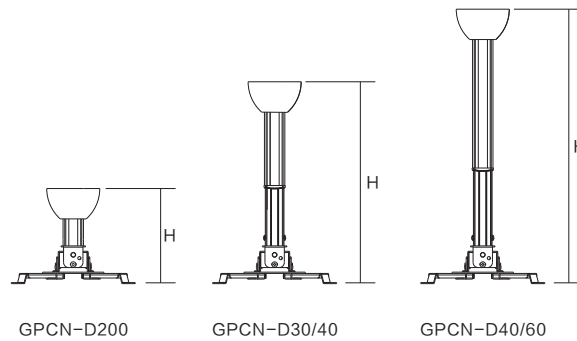

Three steps of installation

- 1 Install the fixation on the ceiling (screws of accessory ① or ⑧) as figure 1, and the fixation also can be installed on the ceiling which angle is less than 15° as figure 2. GPCN-D can be installed to the concrete-roof with ceiling or without ceiling, such as figure 3.

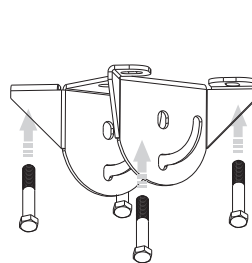

figure 1

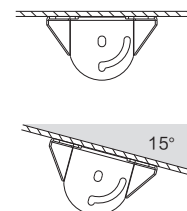

figure 2

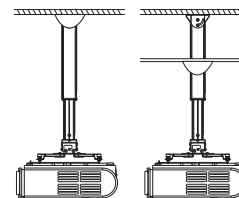

figure 3

Three steps of installation

- 2 Connect the GPCN Main Bar Overview to the fixation (screws of accessory ④). Store the power wire, and then fasten the front and back screws of main bar. Finally, install the ornament board of main bar as figure 4 and figure 5.

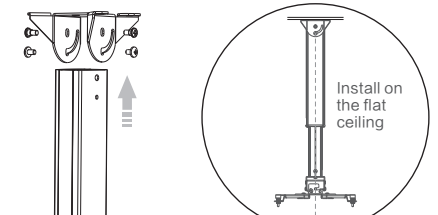

figure 4

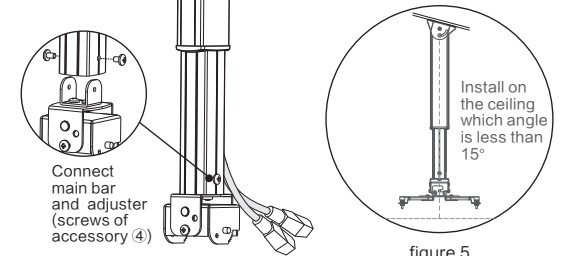

figure 5

- 3 Hang the installation bracket (projector has been installed) to the adjuster as figure 6. And then put in the screws (accessory ③), but do not fasten. Pull the top cup to the main bar, and then invaginate the spring, figure 7

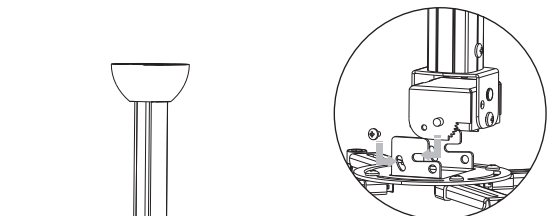

figure 6

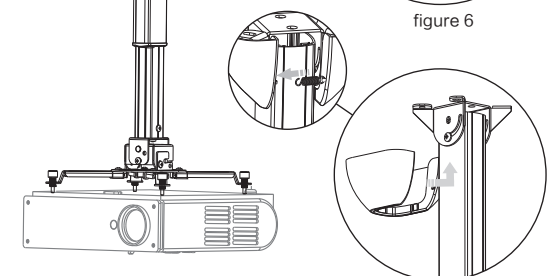

figure 7